



# VERSAI

RESIDENTIAL ORNAMENTAL FENCE

TOUGH // DURABLE // ELEGANT



FortressShield

# PANEL & GATE STYLES

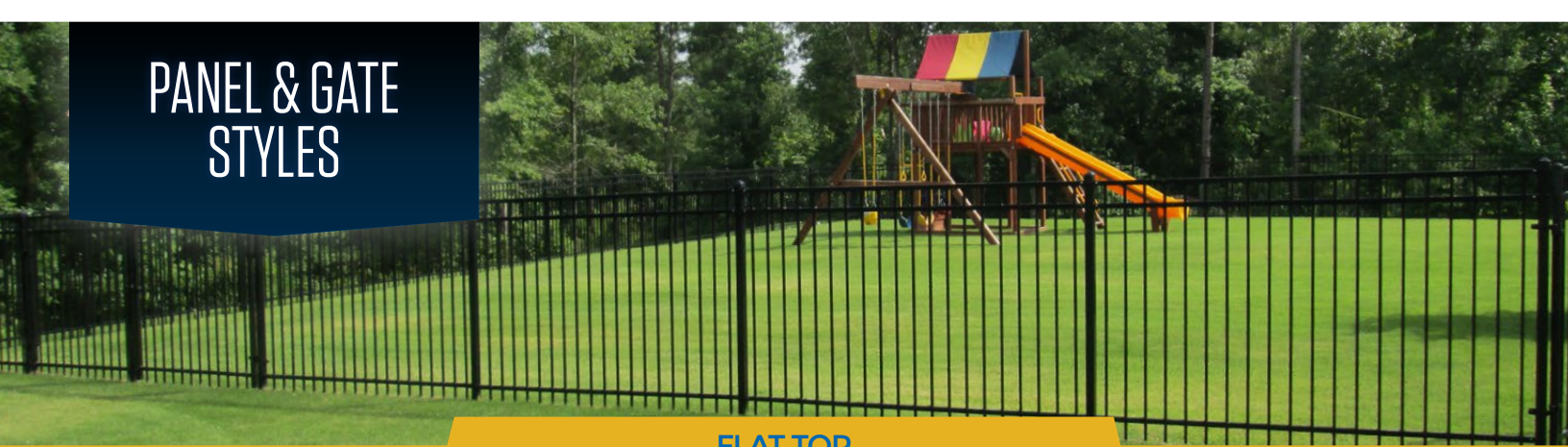

## FLAT TOP

1" X 1-3/16" RAIL // 5/8" PICKET // 1-1/2" GATE UPRIGHTS // 3-7/8" AIR SPACE

### THREE RAIL PANELS

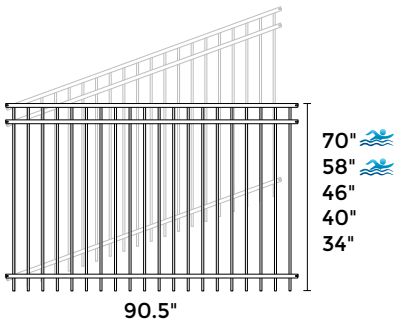

### THREE RAIL GATES

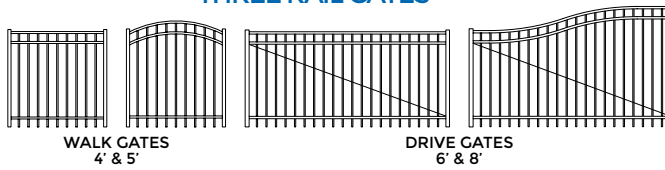

### TWO RAIL PANELS

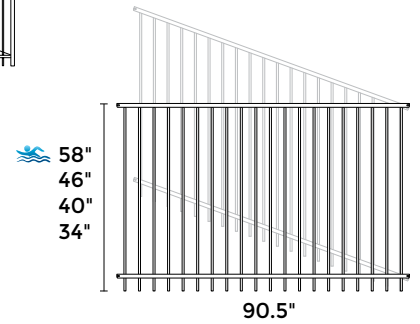

### TWO RAIL GATES

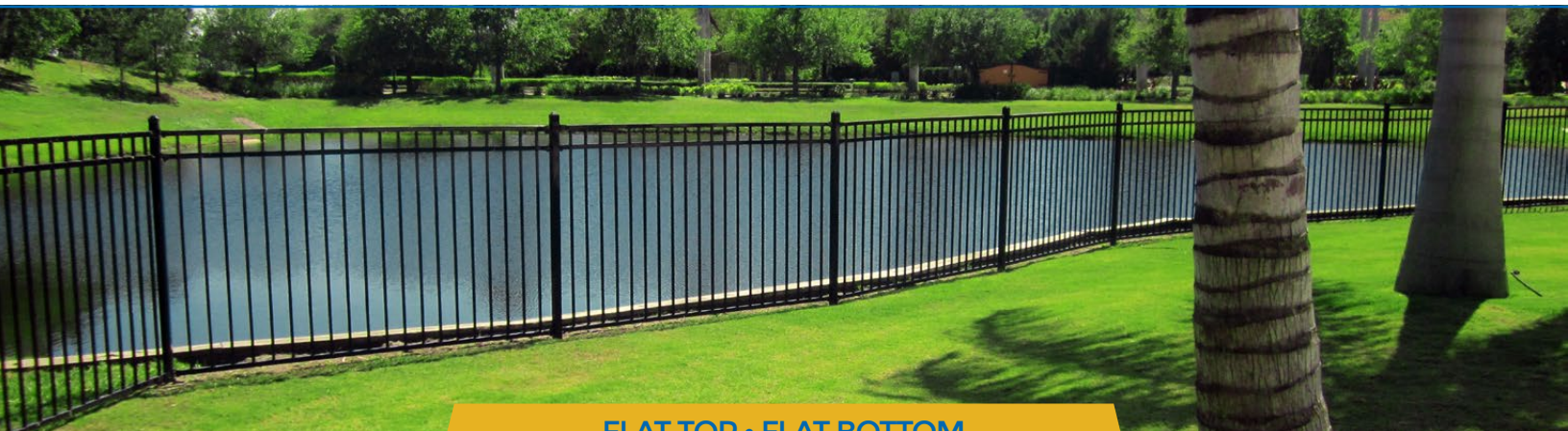
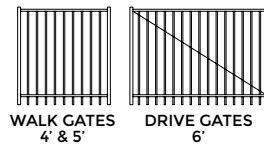

## FLAT TOP • FLAT BOTTOM

1" X 1-3/16" RAIL // 5/8" PICKET // 1-1/2" GATE UPRIGHTS // 3-7/8" AIR SPACE

### THREE RAIL PANELS

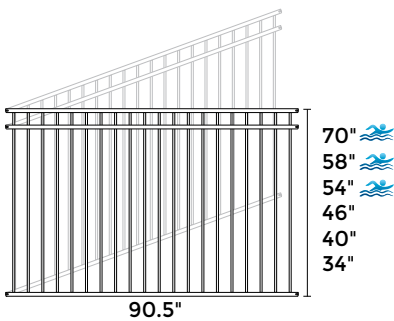

### THREE RAIL GATES

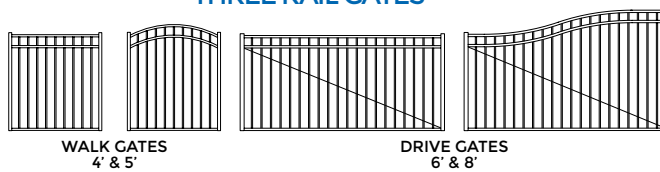

### TWO RAIL PANELS

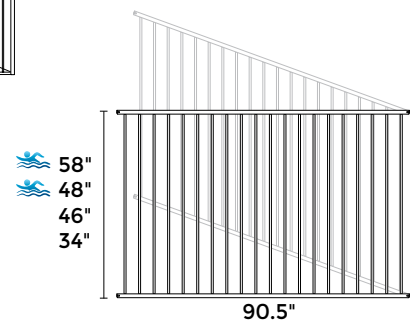

### TWO RAIL GATES

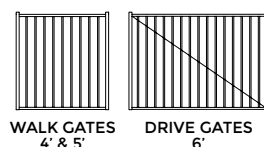

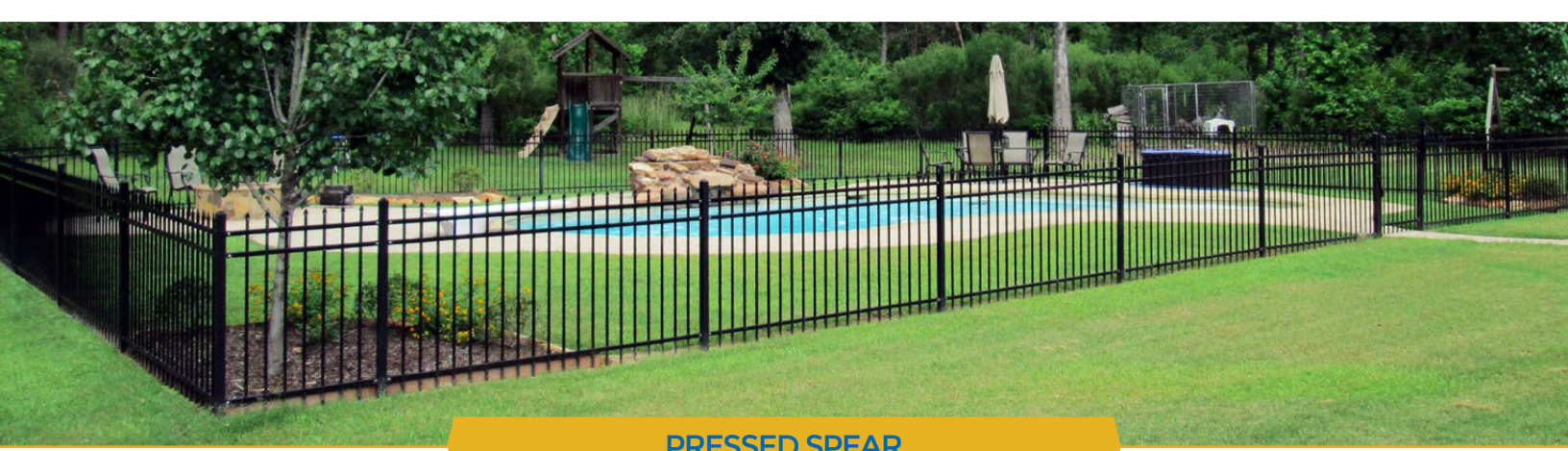

**PRESSED SPEAR**

1" X 1-3/16" RAIL // 5/8" PICKET // 1-1/2" GATE UPRIGHTS // 3-7/8" AIR SPACE

**THREE RAIL PANELS**

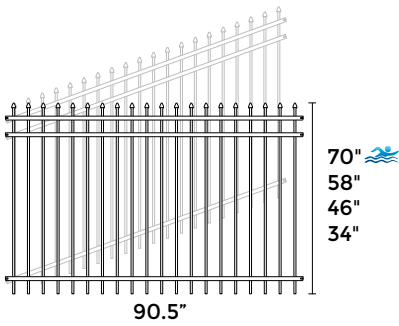

**THREE RAIL GATES**

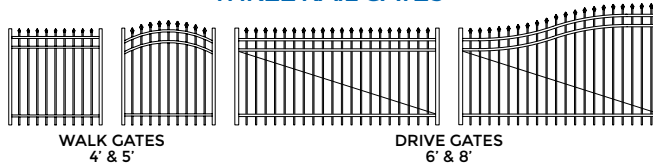

**TWO RAIL PANELS**

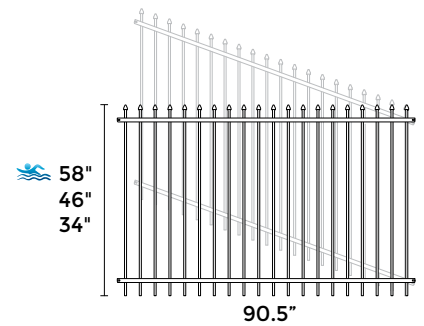

**TWO RAIL GATES**

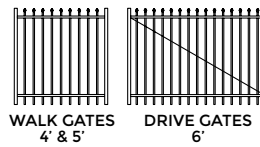

**PRESSED SPEAR • FLAT BOTTOM**

1" X 1-3/16" RAIL // 5/8" PICKET // 1-1/2" GATE UPRIGHTS // 3-7/8" AIR SPACE

**THREE RAIL PANELS**

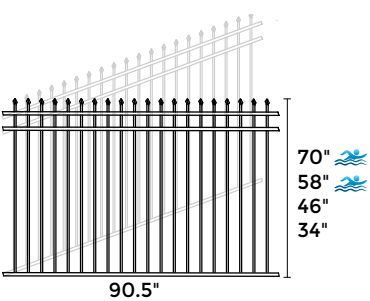

**THREE RAIL GATES**

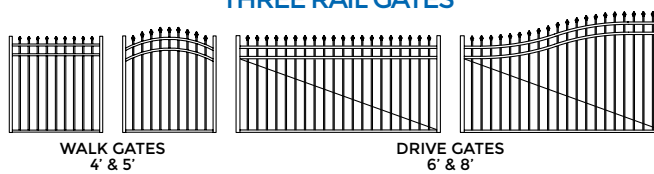

**TWO RAIL PANELS**

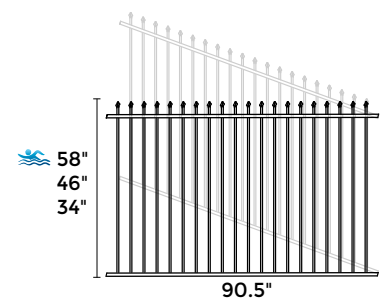

**TWO RAIL GATES**

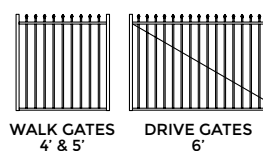

# PANEL & GATE STYLES



## EXTENDED PICKET

1" X 1-3/16" RAIL // 5/8" PICKET // 1-1/2" GATE UPRIGHTS // 3-7/8" AIR SPACE

### THREE RAIL PANELS

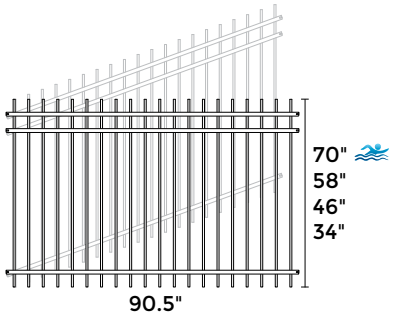

### THREE RAIL GATES

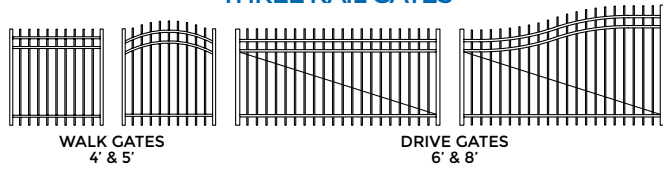

### TWO RAIL PANELS

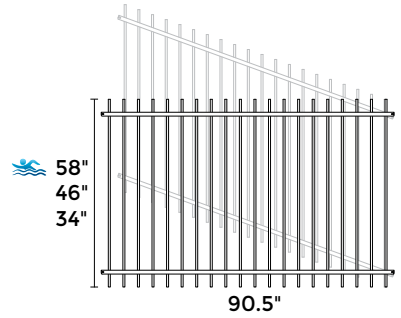

### TWO RAIL GATES

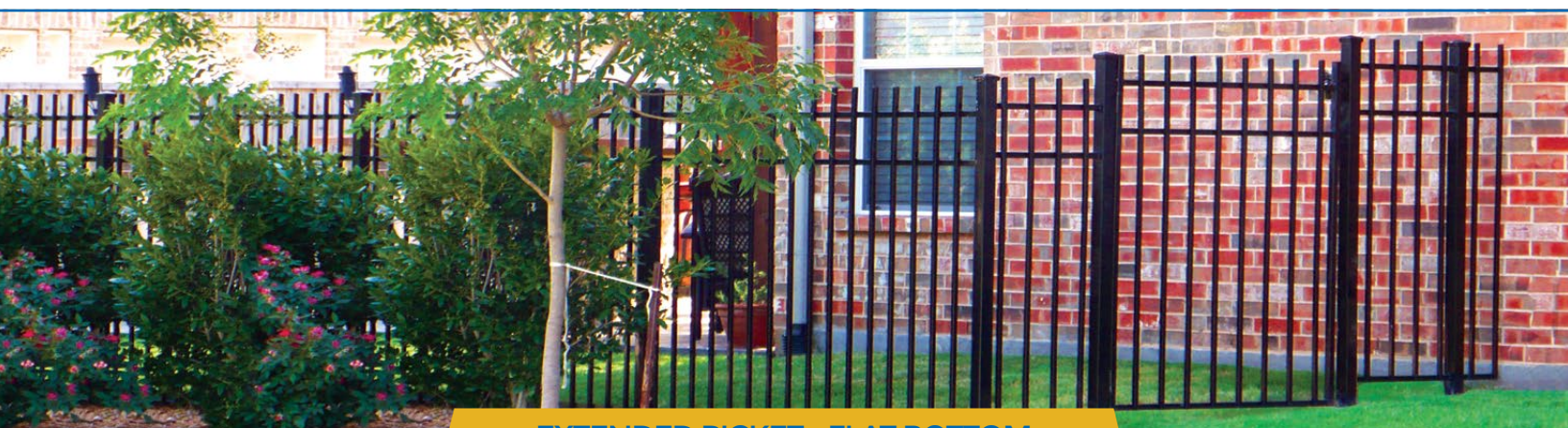
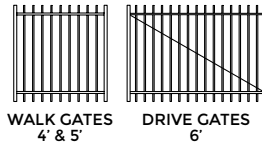

## EXTENDED PICKET • FLAT BOTTOM

1" X 1-3/16" RAIL // 5/8" PICKET // 1-1/2" GATE UPRIGHTS // 3-7/8" AIR SPACE

### THREE RAIL PANELS

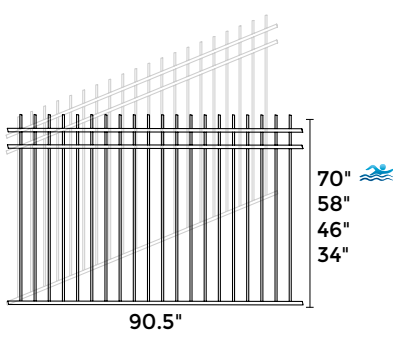

### THREE RAIL GATES

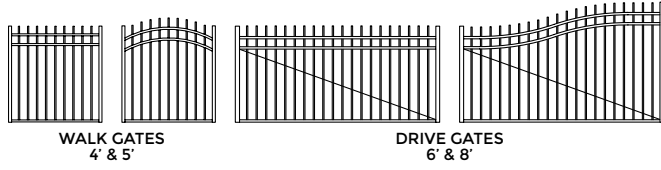

### TWO RAIL PANELS

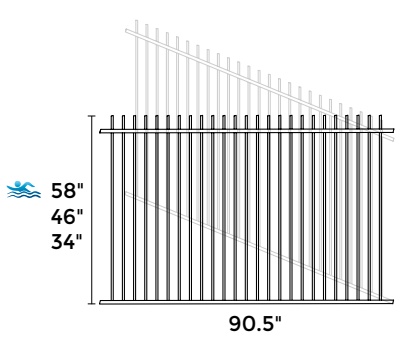

### TWO RAIL GATES

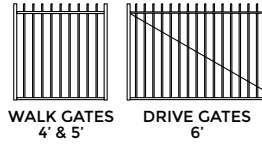

## BRACKETS

ACCOMMODATES 92-5/8" TO 93-3/8" OC SPACING

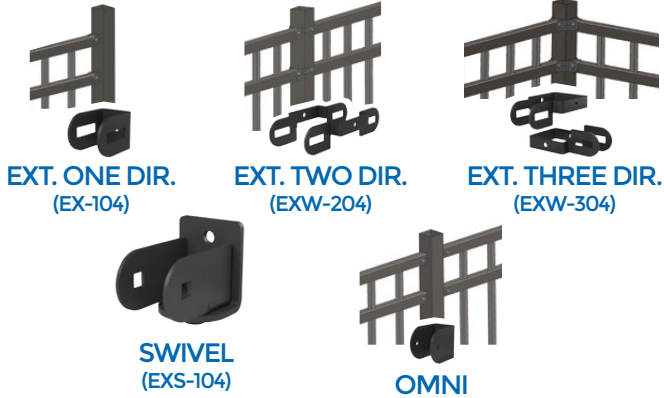

ACCOMMODATES 94-7/8" TO 96" OC SPACING

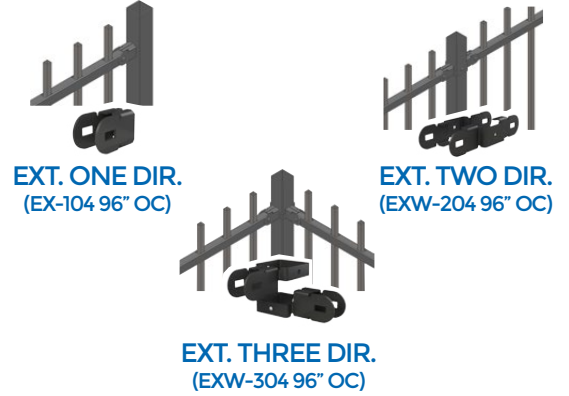

## POSTS & POST ACCESSORIES

WITH BASE

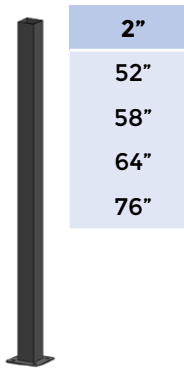

WITHOUT BASE

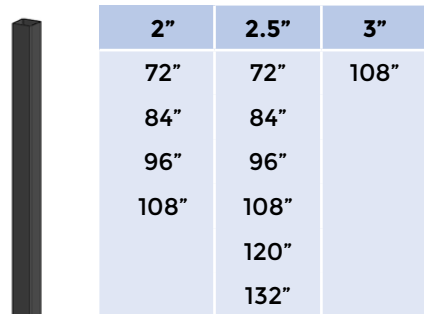

## GATE KIT

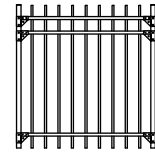

## RESIDENTIAL GATE HARDWARE



## ACCESSORIES



## PROSERIES GATE HARDWARE

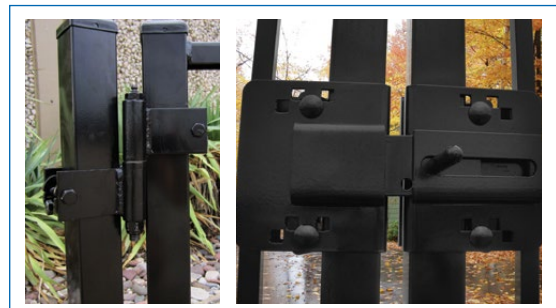



### ASSURANCE (3" AIR SPACE)



Fortress Fence Products' ASSURANCE Panels and Gates are perfect for playgrounds, small pets, and pools. ASSURANCE is available in Versai Residential and Commercial Products. With its 3" air space, rest assured that it'll protect those most precious to you.



### CUSTOM FABRICATION

Fortress Fence Products is proud to offer a full range of custom fabricated gates and panels to meet any project needs. With its own custom fabrication facility, there is a dedicated staff to help design any gate or panel to individual specification and style. Fortress Custom Fabrication is also available in a broad range of premium finishes. Carrying up to a 5-year limited manufacturer warranty, Fortress Custom Fabrication manufactures to a standard of pre-galvanized and premium powder coated steel to provide gates and panels that will withstand the elements. For assistance with developing custom gates or panels, information about custom colors and pricing, please contact us at 1-844-909-1999 or [specifications@fortressfence.com](mailto:specifications@fortressfence.com).

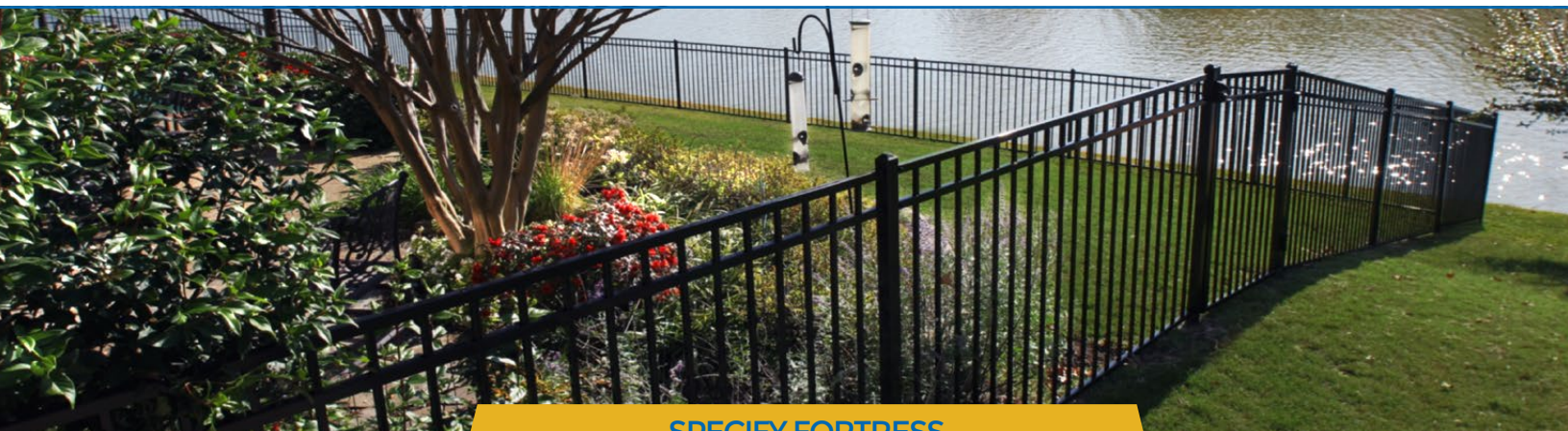

### SPECIFY FORTRESS

Fortress Fence Products is the leading manufacturer of perimeter fence products. We are committed to developing innovative, quality products specifically for the ornamental fence industry. For any drawings or specification related to one of our products, please contact our Commercial Estimating Department 1-844-909-1999 or [specifications@fortressfence.com](mailto:specifications@fortressfence.com). We invite you to visit Fortress Fence on ARCAT.

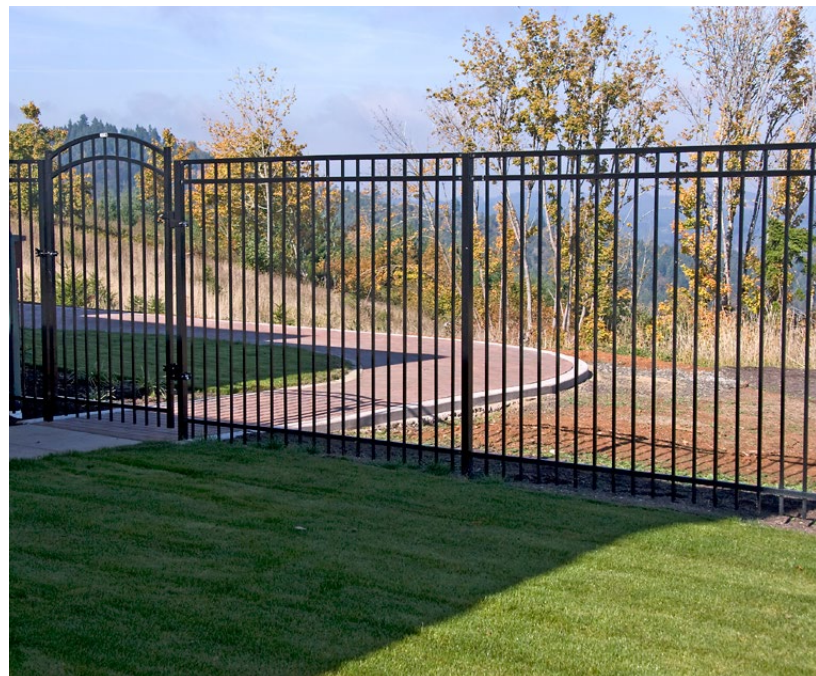
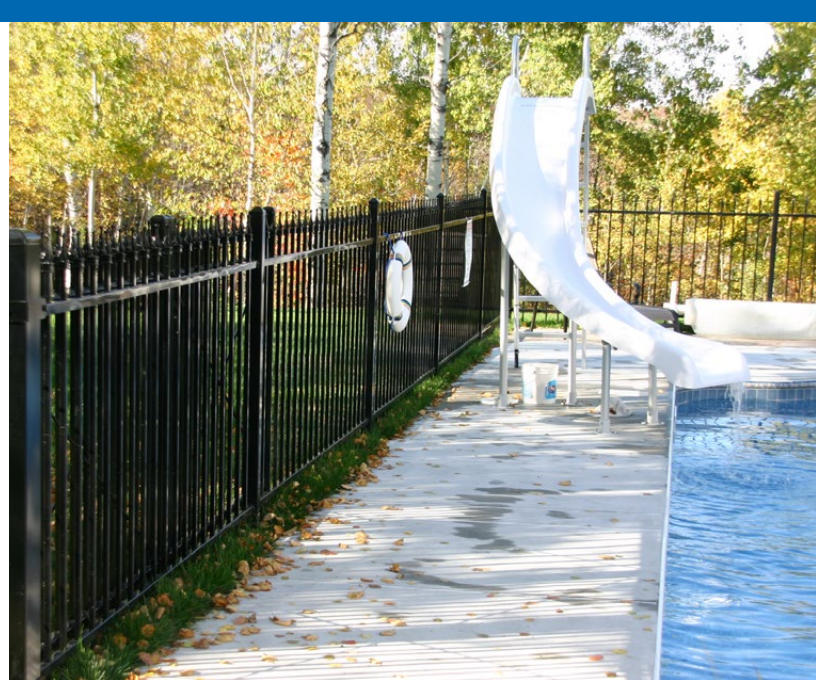
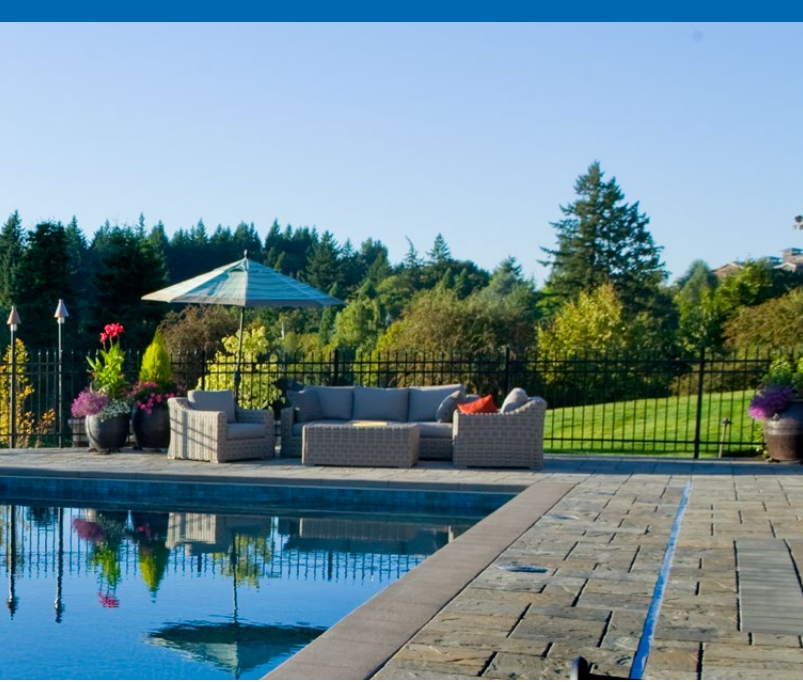

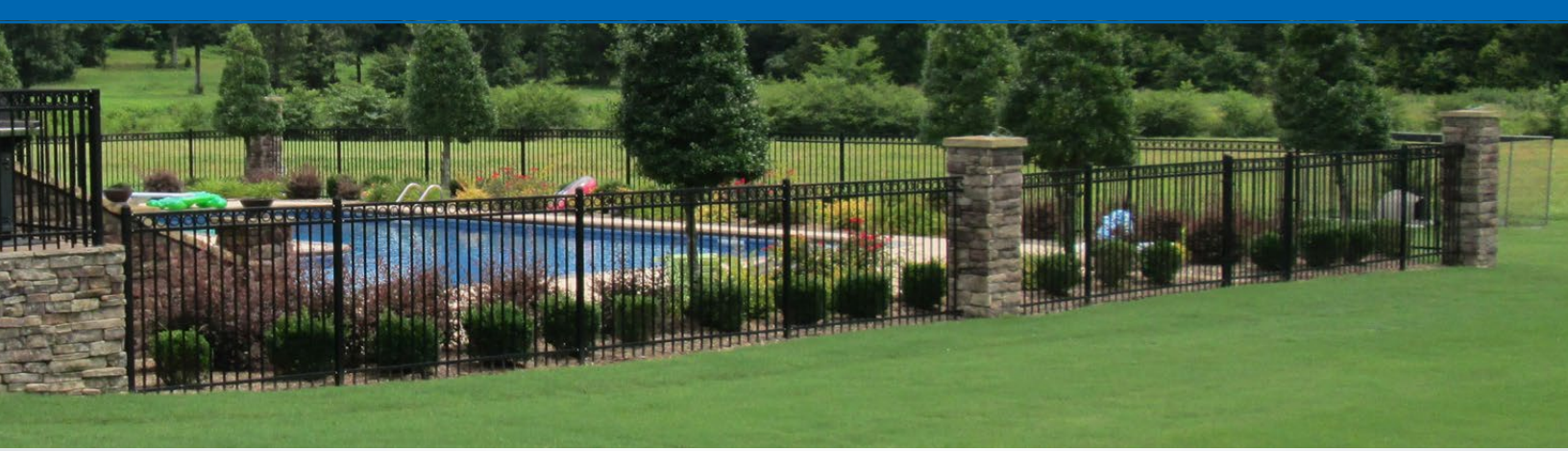

**TOUGH**

- // PATENTED PIN HINGE SYSTEM
- // RIGID WELDED STEEL CONSTRUCTION
- // ADJUSTS TO THE MOST AGGRESSIVE LANDSCAPE
- // STRONGER RAIL STRENGTH
- // TRUE 5/8" SQUARE PICKET

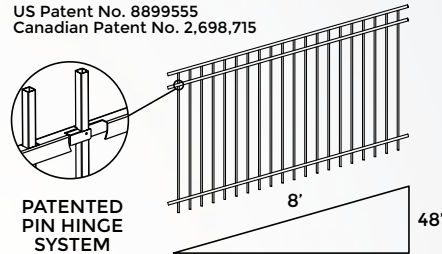

**DURABLE**

- // E-COATED
- // ARCHITECTURAL GRADE POWDER COAT
- // UV INHIBITORS REDUCE FADING OVER TIME
- // VIRTUALLY MAINTENANCE FREE
- // 20 YEAR LIMITED MANUFACTURER WARRANTY



**ELEGANT**

- // SMOOTH RAILS WITHOUT SAG, RIVETS, OR SCREWS
- // MATCHING WALK AND DRIVE GATES
- // VARIETY OF STYLES AND CUSTOM OPTIONS

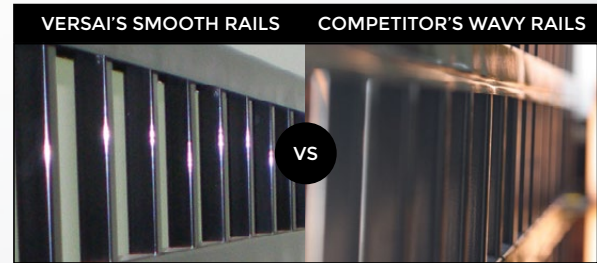

**RESIDENTIAL // COMMERCIAL // INDUSTRIAL**

Fortress Fence Products is a leading manufacturer of ornamental fence systems. We are committed to continually developing innovative, quality products specifically for the ornamental fence industry.

1-844-909-1999 // [www.fortressfence.com](http://www.fortressfence.com)



item 661047